



SERIES 08-02



Precision Snap Disc Thermostats
Surface Mounting Type



office@lico.at

8.10.14

FEATURES

- Ratings to 12A at 240VAC
- 100,000 Cycle Rating
- UL Component Recognized 
- CSA Certified 
- CE Compliant 
- Tamper-Proof Preset Temperature
- Calibrated Settings from 35 to 350°F (2 to 176°C)
- Automatic Reset
- Vibration Resistant

APPLICATIONS

- Power Supplies
- Solar Heating
- Copiers
- Communications Equipment
- Refrigeration Compressors
- Welding Equipment
- Food Processing



DESCRIPTION

A snap-acting bimetal disc serves as the actuating element in these rugged, precision thermostats. As the temperature reaches the tamper-proof predetermined set point, the disc snaps to provide rapid, positive contact action minimizing radio frequency interference and ensuring high reliability.

These thermostats are individually calibrated and tested to meet both thermal and electrical characteristics. The single contact switch arm assembly minimizes failures due to contact contamination, while the fine silver contacts assure long life and excellent current carrying capacity. Resistance to vibration and harsh environments are additional features.

The polyphenylene sulfide base and metal cap provide protection from contamination and an optional epoxy seal improves resistance to harsh environments.

Many terminations and mounting assemblies are available to permit great flexibility in installation.

Thermostats feature current carrying capacities up to 12A at 240VAC measuring .350" in height. An optional epoxy seal provides additional protection against contamination.

TEST SAMPLES

Operating samples can be supplied for application tests. A completed Fenwal Snap Disc Application Data Form is required to select and produce an operating sample. Application Data Forms are available from Fenwal or your local Fenwal sales representative.

The following model is normally available from stock for next day delivery.

NORMALLY CLOSED CONTACTS - OPEN ON RISE				
Part Number	Mounting	Terminals	Opens °F	Close °F
08-020261-463	Movable	T6	140	120

SPECIFICATIONS

Switch Action

SPST (normally open or normally closed)

Dielectric Strength

1500 VAC terminals to case.

Insulation Resistance

100 Megohms minimum at 500VDC.

Vibration

MIL-STD-202D, Method 204B, 10 G's.

Shock

MIL-STD-213B, Test Condition K, 30 G's, 11 millisec.

RANGES AND TOLERANCES

TABLE 1

Series	Temperature Range	Tolerances		Differential (Nominal)
		Open	Closed	
08-02	35 to 240°F 2: to 115°C	± 7F° ± 4C°	± 7F° ± 4C°	20F° 11C°
	241 to 300°F 116 to 148°C	± 7F° ± 4C°	± 8F° ± 4.5C°	25F° 14C°
	301 to 350°F 149 to 177°C	± 8F° ± 4.5C°	± 10F° ± 6C°	30F° 17C°

NOTE: Differences in temperature testing procedures and equipment, between those of the manufacturer and the customer, can result in temperature variances of up to 2°F.

ELECTRICAL RATINGS (Resistive)

TABLE 2

Series	120VAC	240VAC	30VDC	Cycles	Approvals
08-02	12A 120VA	12A 120VA	2A —	100,000 100,000	



 and  units rated for AC operation only.
 U.L. File E18974, Guide XAPX2.
 C.S.A. File LR 7378, Class 4823 02.
 Certified by BG Technology 

TABLE 3

Mounting Bracket - Stainless Steel

B1—No Bracket (Cap Only)

B2—Bottom Oval Flange

B6—Stud Mounting Screw

Mounting Hardware Size

H1—No hardware (use with B1)

H4—#6 screw for flange mounting

H6—#6 screw for stud mounting

Terminals Positions

T1—Eyelet, opposed horizontal

T2—Eyelet, opposed vertical

T3—Eyelet, parallel horizontal

T4—Eyelet, parallel horizontal, reverse step

T6—1/4" Quick Connect, opposed horizontal

T7—1/4" Quick Connect, opposed vertical

T10—Leads, opposed horizontal

T11—Leads, opposed vertical

T12—Leads, parallel horizontal

T13—Leads, parallel vertical

T14—Vertical lead wires with epoxy filled mylar sleeve

Lead Wires (specify length)

L1—No Lead Wires

L2—105°C PVC, 18 AWG, 600V insulation

L3—200°C TFE, 18 AWG, 300V insulation

L4—250°C TGGT, 18 AWG, 300V insulation

OUTLINE DIMENSIONS

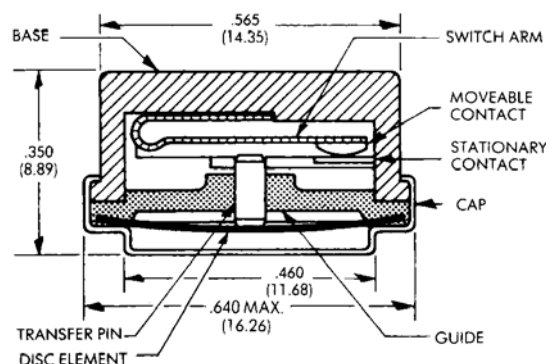

TERMINALS AND POSITIONS

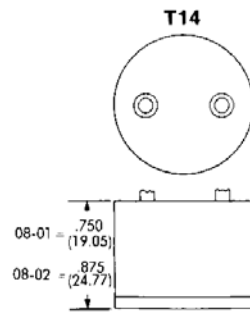
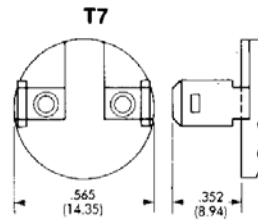
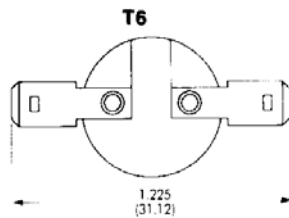
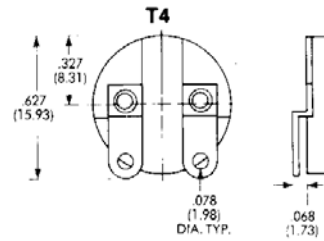
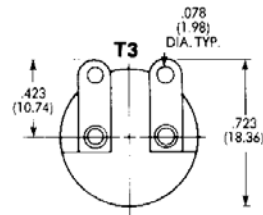
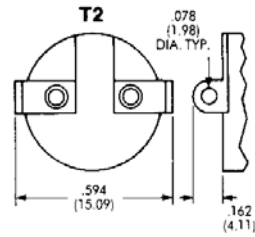
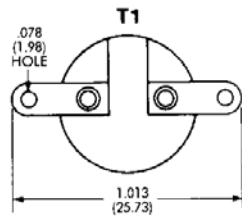

Dimensions in brackets are millimeters.

Specifications subject to change without notice.

MOUNTING BRACKETS

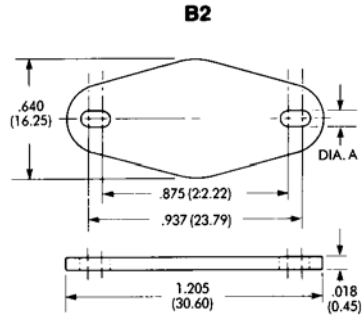

Hardware Size	Dim. A
H4	.143 (3.63)

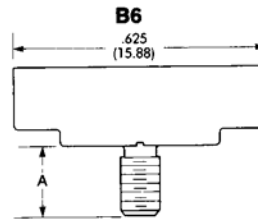

Hardware Size	Dim. A
H6	6-32 x 3/8"

HOW TO ORDER

To more clearly define specific requirements, please complete a Fenwal Snap Disc Application Data Form, available from Fenwal or your local Fenwal sales representative.

TO ORDER:

1. Select Series Number desired from Table 1 on Page 2.
2. Specify opening and closing temperatures in degrees Fahrenheit or Celsius with tolerances; and whether the switch action should open or close on temperature rise.
3. Specify terminals and mounting configurations by selecting one code number from each category in Table 3. If lead wires are required, specify length.

EXAMPLE:

08-02, open at 175°F, close at 155°F, B2, C3, H4, T1, L1 = Series 08-02 thermostat set to open at 175°F ± 7°F on temperature rise, close at 155°F ± 7°F on temperature drop. Bottom oval flange mounting bracket; holes to accept #6 mounting hardware (not supplied); eyelets, opposed horizontal; no lead wires.



LICO Electronics GmbH,
 A-2320 Kledering, Klederinger Str. 31
 www.mess-regeltechnik.at,
 office@lico.at h.miksch@lico.at
 Tel +43 1 706 43 000 Fax +43 1 706 41 31
 © 2009 Fenwal

These instructions do not purport to cover all the details or variations in the equipment described, nor do they provide for every possible contingency to be met in connection with installation, operation and maintenance. All specifications are subject to change without notice. Should further information be desired or should particular problems arise which are not covered sufficiently for the purchaser's purposes, the matter should be referred to LICO,

P/N 8.10.14